

# User's Manual

## CNPS10X Performa

Intel Socket 1366/1156/775 CPU

- Core i7
- Core i5
- Core i3
- Core 2 Quad
- Core 2 Duo
- Core 2 Extreme
- Dual Core Pentium
- Pentium D
- Pentium 4
- Celeron D

AMD Socket AM3/AM2+/AM2/754/939/940 CPU

- Phenom II
- Phenom
- Athlon II X2
- Athlon
- Athlon 64
- Athlon X2
- Athlon 64 X2
- Athlon FX
- Athlon 64 FX
- Opteron
- Dual-Core Opteron
- Sempron

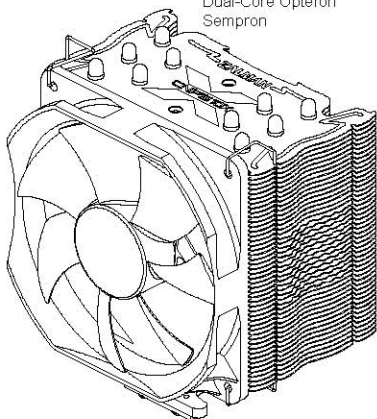

To ensure safe and easy installation,  
please read the following precautions

<http://www.zalman.com>

## 1. Precautions

- 1) This cooler must be used with a 120mm fan.
- 2) Do not ingest the Thermal Grease, and avoid its contact with skin and eyes. If contact is made with skin, wash off with water. If ingested or irritation persists, seek medical attention.
- 3) To prevent possible injuries, gloves must be worn while handling this product.
- 4) Excessive force exerted on the fan may cause damage to the fan and/or system.
- 5) Use and keep product away from reach of children.
- 6) Check the components list and condition of the product before installation. If any problem is found, contact the retailer to obtain a replacement.
- 7) During transportation of the system, the cooler must be removed. Zalman is not responsible for any damages that occur during the transport of a system.
- 8) Product design and specifications may be revised to improve quality and performance.

## 2. Specifications

| Spec.                        |                                  | Model                      | CNPS10X Performa              |
|------------------------------|----------------------------------|----------------------------|-------------------------------|
| Material                     |                                  | Pure Copper and Aluminum   |                               |
| Weight                       |                                  | 748g                       |                               |
| Dimensions                   |                                  | 132(L) X 100(W) X 152(H)mm |                               |
| Fan                          | Bearing-Type                     |                            | Long Life Bearing             |
|                              | Low Noise Mode<br>[with RC24P]   | RPM                        | 900 ~ 1350 rpm $\pm$ 10%      |
|                              |                                  | Noise Level                | 17 ~ 24 dBA $\pm$ 10%         |
|                              | Performa Mode<br>[without RC24P] | RPM                        | 900 ~ 2000 rpm $\pm$ 10%      |
| Noise Level                  |                                  | 17 ~ 36 dBA $\pm$ 10%      |                               |
| Thermal Grease<br>[ZM-STG2M] |                                  | Contents                   | 1g                            |
|                              |                                  | Temperature Range          | -40°C ~ +150°C (-40 ~ +302°F) |

## 3. Components

### 1) Common Components

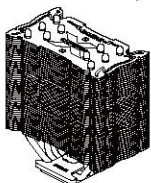

Cooler

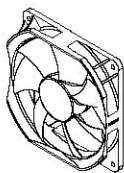

Fan



User's Manual

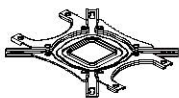

Backplate

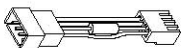

Resistor[RC24P]



Side Cap

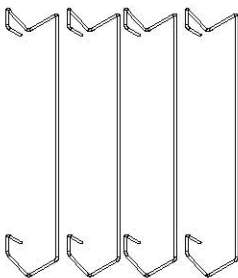

Fan Fixing Clips

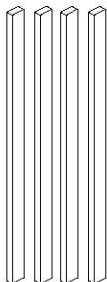

Anti-vibration Pads

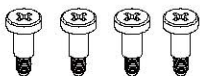

Bolts



Nuts



Thermal Grease  
[ZM-STG2M]

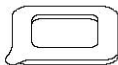

Double-sided Tape

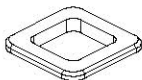

Loading Block

### 2) Intel Components

Socket 775 / 1156 / 1366

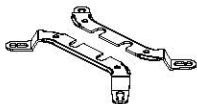

Intel Clip

### 3) AMD Components

Socket AM3 / AM2+ / AM2

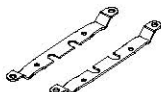

AMD Clip A

Socket 754 / 939 / 940

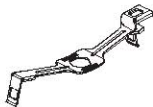

AMD Clip B

## 4. Installation Requirements

### 1) Space Requirements

The cooler's installation requires an unobstructed space of 137mm(width), 130mm (length), and 155mm(height), with the CPU as a central reference point. Please check if components such as ODDs and PSU protrude into the required space.

### 2) Air Guide Removal

Air guides on enclosures must be removed before the cooler's installation since they protrude into the cooler's required space.

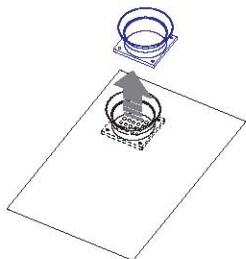
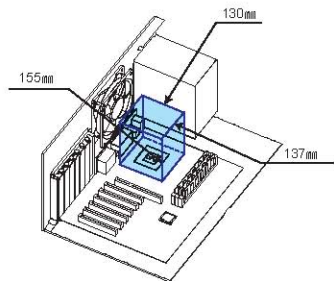

### 3) Cooler Orientation

As shown in the diagram below, it is recommended that the cooler be installed so that air flows from the cooler toward the enclosure's rear exhaust fan to be released.

※ Install the fan so that the ZALMAN logo is oriented in relations to the rear of the case as in the diagram.

※ Recommended cooler orientation may differ according to the motherboard model.

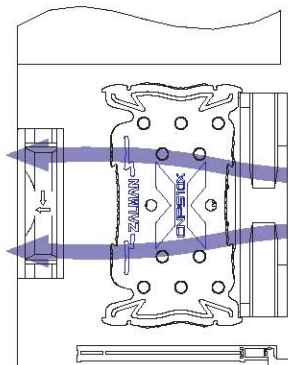

### 4) CPU and RAM interference check (limited to systems with RAM heatsinks)

For Intel and AMD Socket motherboards's with a RAM height of 36mm (1.42") and greater, there will be physical interference with the CPU cooler resulting in the inability to utilize dual and full-channel modes. Please check the height of your RAM modules prior to installation.

## 5. Installation

### 1) Intel Socket 1156/775 and Socket 1366 Installation

- ① Unfasten the Bolts on the Cooler's Base one thread, insert the Intel Clip between the Cover and the Base, and then refasten the Bolts.

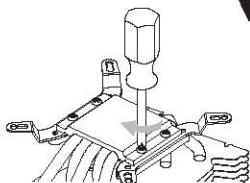
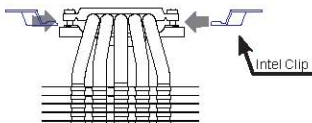
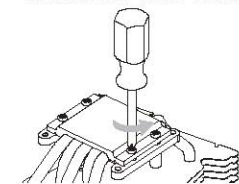

#### ⚠ Caution

Make sure the Intel Clip's ingresses are flush against the protrusions of the Base Cover.

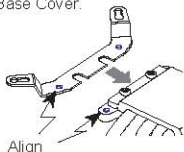

- ② Install Bolts to the Backplate according to the Socket Type and secure with Side Caps.

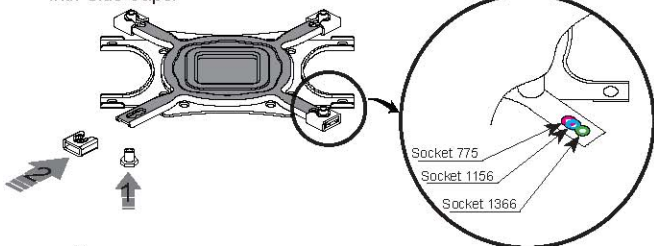

#### ⚠ Caution

Take note of the orientation of the Nuts and the Side Caps.

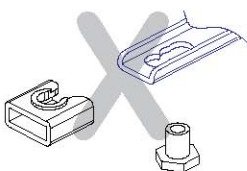
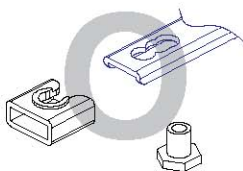

## ③ - ① Socket 775 Installation

Remove the Sticker Cover from the Lower Tier of the Loading Block and attach to the Backplate.

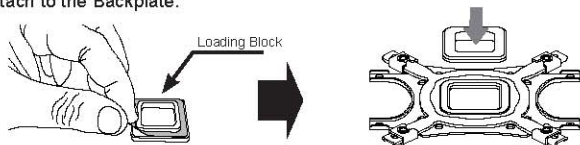

Attach Double-sided Tape to the Loading Block and remove the Double-sided Tape Cover.

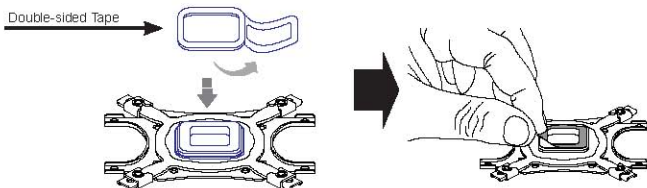

## ⚠ Caution

Please make note of the orientation of the Loading Block's Installation.

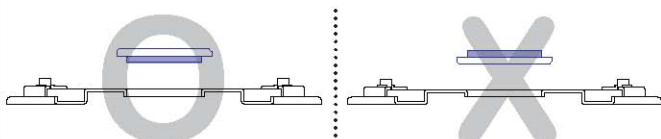

## ③ - ② Socket 1156/ 1366 Installation

Attach Double-sided Tape to the center of the Backplate and remove the Double-sided Tape's Cover.

※ Socket 1156/1366 Installation does not require the Loading Block.

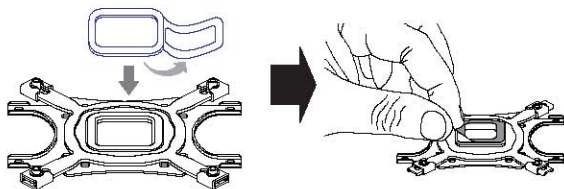

- ④ Align the Backplate's Nuts with the motherboard's Clip Support's installation holes and fasten to the motherboard.

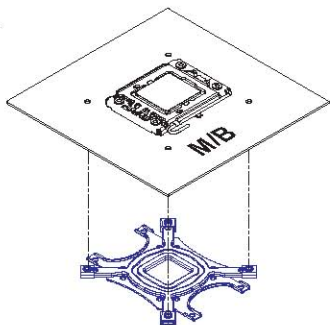

- ⑤ Apply the enclosed Thermal Grease to the CPU's surface and install the Cooler by fastening the Bolts.

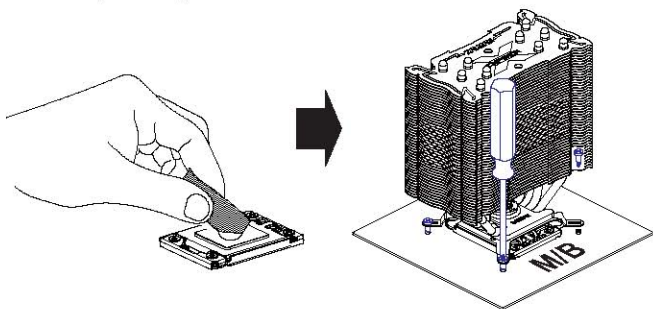

- ⑥ Attach the Anti-vibration Pads to the Cooler.

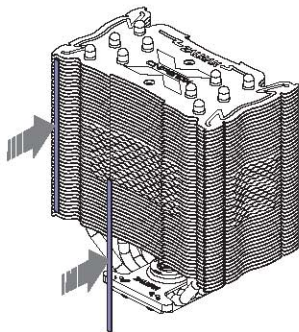

- ⑦ Fasten the Fan using the Fan Fixing Clips.

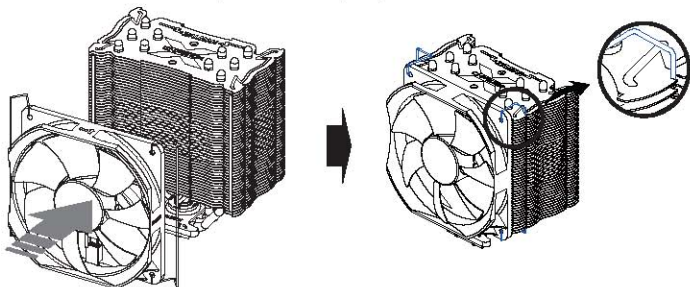

- ⑧ Connect the cooler's 4-pin connector to the motherboard's CPU Fan header.

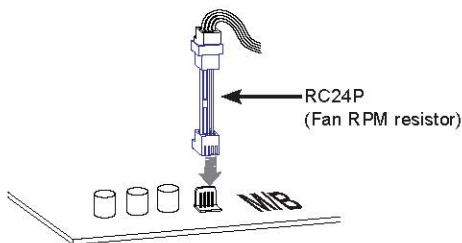

Tip

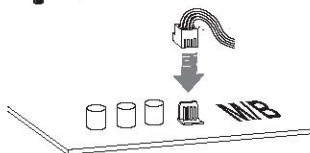

This model comes equipped with the RC24P resistor for Low Noise Mode.

For Performa Mode, remove the RC24P resistor and connect the Fan Connector to the motherboard.



Caution

Please make sure that PWM Control Mode is activated in the motherboard's BIOS settings.



## 2) AMD Socket AM3 / AM2+ / AM2 Installation

- ① Unfasten the Bolts on the Cooler's Base one thread, insert the AMD A Clip between the Cover and the Base, and then refasten the Bolts.

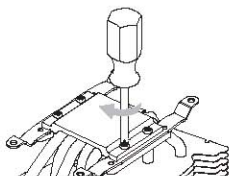
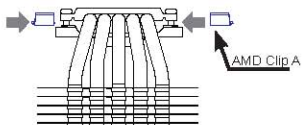
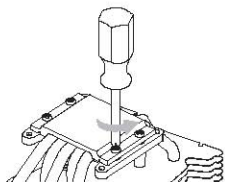

**⚠ Caution**

Make sure the AMD A Clip's ingresses are flush against the protrusions of the Base Cover.

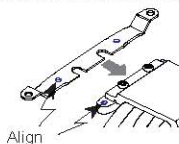

- ② Install Bolts to the Backplate according to the Socket Type and secure with Side Caps.

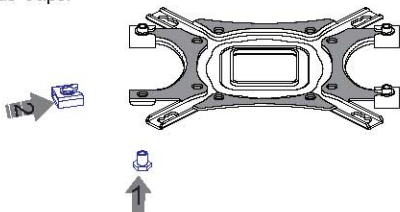

**⚠ Caution**

Take note of the orientation of the Nuts and the Side Caps.



- ③ Remove the Sticker Cover from the Lower Tier of the Loading Block and attach to the Backplate.

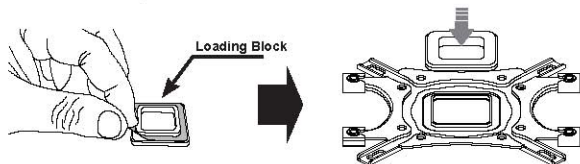

Attach Double-sided Tape to the Loading Block and remove the Double-sided Tape Cover.

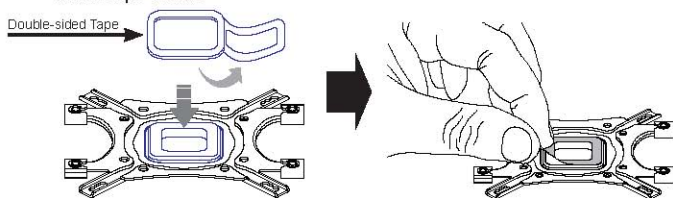

### ⚠ Caution

Please make note of the orientation of the Loading Block's Installation.

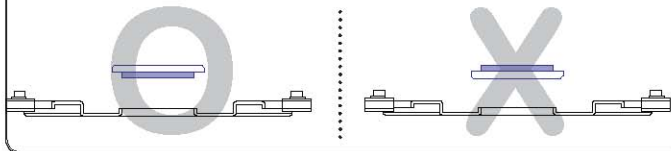

- ④ Disassemble the motherboard's Clip Support.

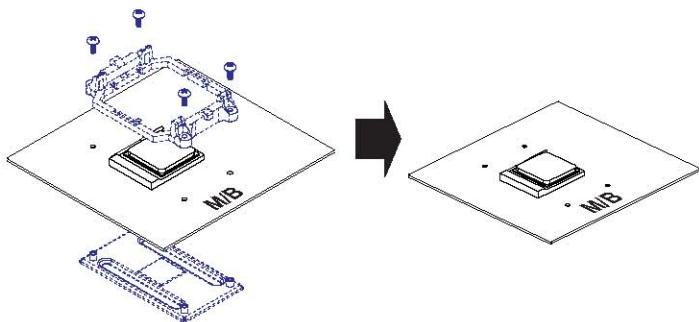

- ⑤ Align the Backplate's Nuts with the motherboard's Clip Support's installation holes and fasten to the motherboard.

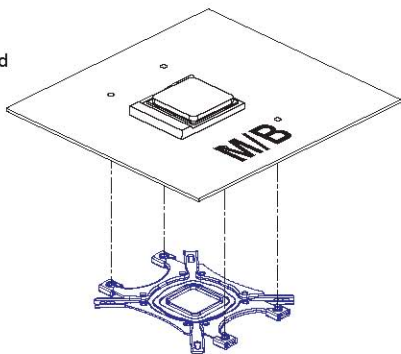

- ⑥ Apply the enclosed Thermal Grease to the CPU's surface and install the Cooler by fastening the Bolts.

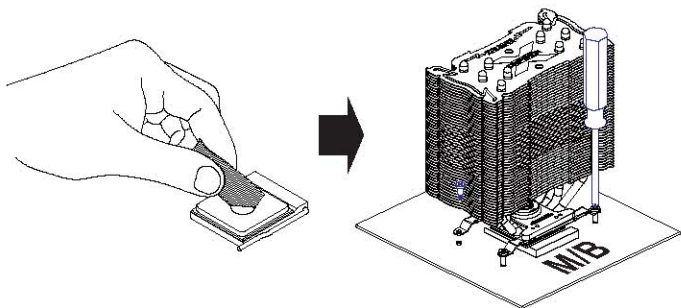

- ⑦ Attach the Anti-vibration Pads to the Cooler.

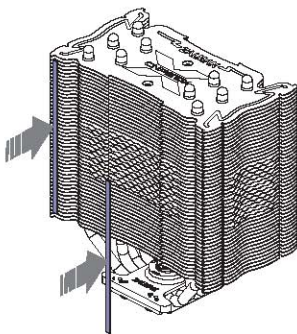

⑧ Fasten the Fan using the Fan Fixing Clips.

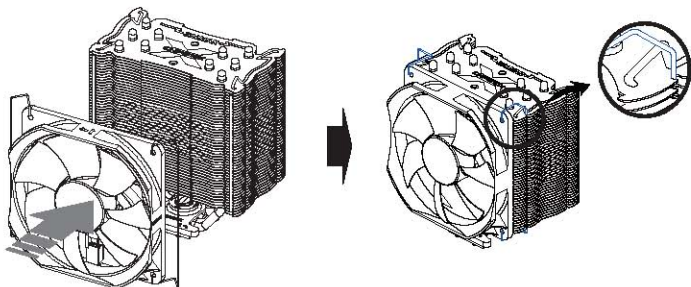

⑨ Connect the cooler's 4-pin connector to the motherboard's CPU Fan header.

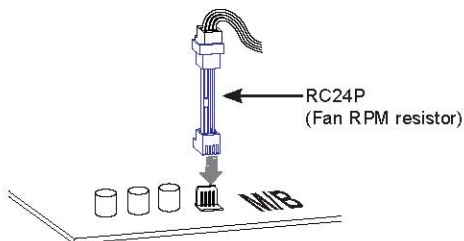

 Tip

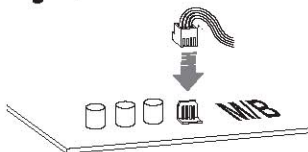

This model comes equipped with the RC24P resistor for Low Noise Mode.

For Performa Mode, remove the RC24P resistor and connect the Fan Connector to the motherboard.

 Caution

Please make sure that PWM Control Mode is activated in the motherboard's BIOS settings.

### 3) AMD Socket 754 / 939 / 940 Installation

- ① Apply the enclosed Thermal Grease to the CPU's surface.

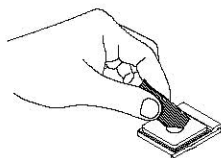

- ② Center the Cooler on top of the CPU and press down on the Clip Lever after fastening the AMD B Clip's Square End to the Clip Support Lug Slot.

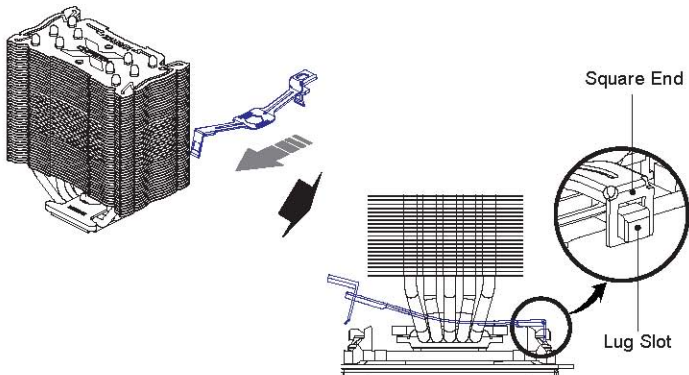

- ③ Attach the Anti-vibration Pads to the Cooler.

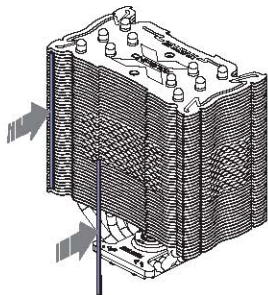

- ④ Fasten the Fan using the Fan Fixing Clips.

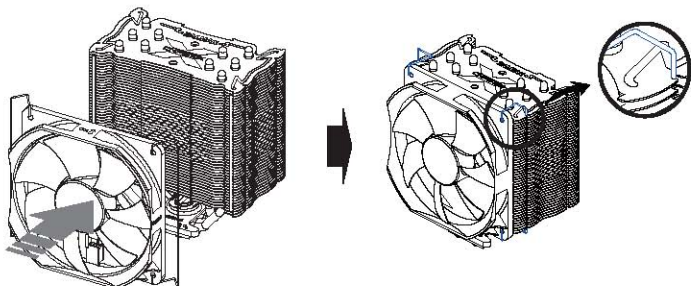

- ⑤ Connect the cooler's 4-pin connector to the motherboard's CPU Fan header.

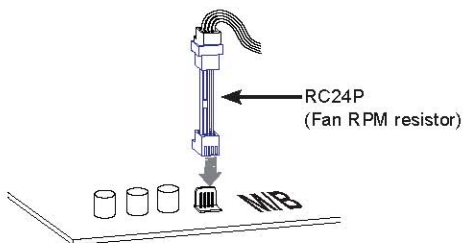

Tip

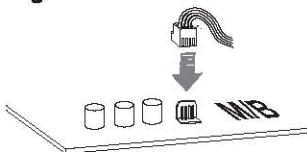

This model comes equipped with the RC24P resistor for Low Noise Mode.

For Performa Mode, remove the RC24P resistor and connect the Fan Connector to the motherboard.



Caution

Please make sure that PWM Control Mode is activated in the motherboard's BIOS settings.